



Way of Life!

A word from Suzuki engineers

Keiji Sasaki (Product Planning Group)

In charge of Strength Analysis. Suzuki Employee for 5 years.

On the DF300AP/250AP, I was mainly responsible for computer analysis of the lower unit gears. We focused a lot on how we could increase reliability and durability in the lower unit without sacrificing driving performance of a conventional outboard. To do this we used the latest computer analysis to create a gear that is significantly more durable. At the same time we made sure that the gear case was rigid enough to accommodate the Suzuki Selective Rotation System. The finished design is slightly larger than the conventional but making full use of computer analysis, we could create a design with less resistance than that of the previous. Overall, driving performance and reliability for this gear case is higher than the conventional model. As Suzuki's flagship outboard, we are very proud of the finished product and hope as many boaters as possible try it out.

Masaya Nishio (Development Design Group)

In charge of Electronic Components. Suzuki Employee for 5 years.

I adapted the troll control introduced on the DF90A for use on the DF300AP/250AP. With the DF90A, multi-outboard installations required that each engine be fitted with a switch to control engines individually. With the DF300AP/250AP however, the BCM (Boat Control Module), which allows control of multiple outboards, could provide troll control to all engines in the group using a single switch. Initially, we had some difficulties with multi-outboard installations, however repeating detailed analysis of issues such as the conditions during the transition into and the deactivation of troll control, and a buzzer control allowed us to build a user-friendly system.

Masahiro Nanba (Experiment Group)

In charge of Experiment. Suzuki Employee for 4 years.

On the DF300AP/250AP, we created a more advanced Suzuki Lean Burn system by combining the lean burn system developed on the DF90A/80A/70A, DF60A/50A/40A, with the DF300DBW (Drive By Wire) system. Also, using the O₂ sensor for feedback control increased the accuracy of the air-fuel ratio delivering more stable and cleaner emissions compared to the previous system. During development we focused on balancing fuel economy and drivability. Using the lean burn system with O₂ feedback, we spent a lot of time trying to obtain the best balance without sacrificing drivability. We feel this technology is worthy of being on Suzuki's flagship outboard providing boaters with a product we hope will satisfy.

Shuichi Sugiyama (Development Design Group)

In charge of Lower Unit. Suzuki Employee for 6 years.

The most difficult part in developing the Suzuki Selective Rotation system was in finding the right balance of structure and gear durability. To achieve success, we stuck to the fundamentals. For example, gears deliver needed function and durability when their support structure is stable, so with the gear layout we focused on keeping the drive and propeller shafts on the same plane as much as possible, which increased gear performance. Suzuki is the first outboard manufacturer in the world to introduce a selective rotation system. I'm looking forward to the day in the future when we will look back on outboard motor design and recall "those old counter-rotation models that they used to make".

DF300AP/250AP SPECIFICATIONS

MODEL	DF300AP	DF250AP
ENGINE TYPE	4-Stroke DOHC 24-Valve	
FUEL DELIVERY SYSTEM	Multi Point Sequential Electronic Fuel Injection	
TRANSOM HEIGHT mm (in.)	X: 635 (25), XX: 762 (30)	
STARTING SYSTEM	Electric	
DRY WEIGHT kg (lbs.) <small>including battery cable, not including propeller and engine oil</small>	X: 274 (604), XX: 279 (615)	
NO. OF CYLINDERS	V6 (55-degree)	
PISTON DISPLACEMENT cm ³ (cu.in.)	4,028 (245.6)	
BORE x STROKE mm (in.)	98 x 89 (3.81 x 3.46)	
MAXIMUM OUTPUT kW(PS)/rpm	220.7 (300)/6000	184 (250)/5800
FULL THROTTLE OPERATING RANGE rpm	5700-6300	5500-6100
STEERING	Remote	
OIL PAN CAPACITY Lit (U.S. / Imp. qt.)	8.0 (8.5/7.0)	
IGNITION SYSTEM	Fully-transistorized	
ALTERNATOR	12V 54A	
ENGINE MOUNTING	Shear Mount	
TRIM METHOD	Power Trim and Tilt	
GEAR RATIO	2.08 : 1 (Two-stage Reduction Gear)	
GEAR SHIFT	F-N-R (Electronic)	
EXHAUST	Through Prop Hub Exhaust	
DRIVE PROTECTION	Rubber Hub	
PROPELLER SIZE (in.)	Regular and Counter Rotation	
Diameter x Pitch	16 x 15**	15-1/2 x 17
	16 x 17	15-1/4 x 19
3-BLADE STAINLESS STEEL TYPE	16 x 18.5	15 x 21
	16 x 20	14-3/4 x 23
	16 x 21.5	14-1/2 x 25
	16 x 23	14-1/2 x 27
	16 x 24.5	
	16 x 26	
	16 x 27.5**	**Regular Rotation only

DIMENSIONS

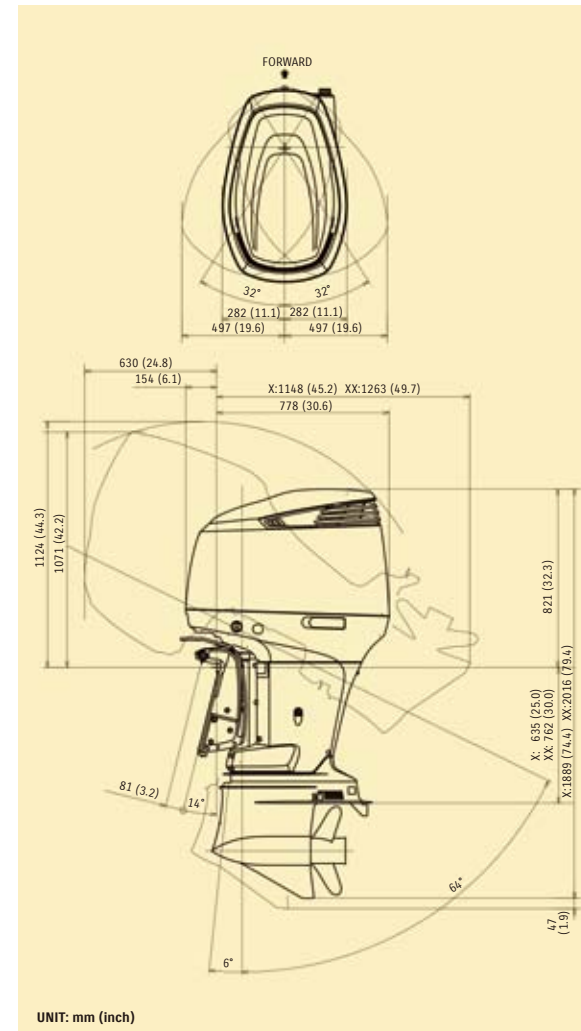

* Boats and motors come in a large variety of combinations. See your authorized dealer for correct prop. selection to meet recommended RPM range at W.O.T.

Please read your owner's manual carefully. Remember, boating and alcohol or other drugs don't mix. Always wear a personal flotation device when boating. Please operate your outboard safely and responsibly. Suzuki encourages you to operate your boat safely and with respect for the marine environment.

Specifications, appearances, equipment, colors, materials and other items of "SUZUKI" products shown on this catalogue are subject to change by manufacturers at any time without notice and they may vary depending on local conditions or requirements. Some models are not available in some territories. Each model might be discontinued without notice. Please inquire at your local dealer for details of any such changes. Actual body color might differ from the colors in this brochure.



SUZUKI MOTOR CORPORATION

300 TAKATSUKA-CHO, MINAMI-KU, HAMAMATSU CITY, JAPAN 432-8611

99999-C2048-041 DF300AP/250AP LEAN BURN Product Information © Printed in Japan 1205

PRODUCT INFORMATION



SUZUKI
SELECTIVE ROTATION

DF300AP/250AP

LEAN BURN

The World's First Selective Rotation Outboards

Award Winning Design Integrates both Regular and Counter-Rotation Operation into a Single Unit

Showcasing Suzuki's advanced technologies and designs, Suzuki's flagship DF300 outboard has been recognized twice as the most innovative outboard in the industry. The original DF300 was launched as the world's first 220.7kW (300PS) 4-stroke outboard and was acknowledged for this by the National Marine Manufacturers Association (NMMA) with its 2006 Innovation Award.

The new DF300AP incorporates several new features, the most notable being Suzuki Selective Rotation. By strengthening the lower unit's forward and reverse gearing, Suzuki engineers have designed a lower unit for the DF300AP that will run in either right or left rotation. With this world's first feature, the DF300AP was recognized once again with the 2012 NMMA Innovation Award.

The DF250AP is based on the DF300AP and shares the same award winning innovations and designs of Suzuki's flagship outboard. Advanced features like Suzuki Selective Rotation, Suzuki Precision Control, and Suzuki Lean Burn Control, plus big V6 power combine to provide boaters with outstanding performance and great convenience.

* Make sure you consult with your dealer before changing Regular Rotation to Counter Rotation (or vice versa).

Main Features of the New DF300AP/250AP

- Rated at 220.7kW (300PS)/184kW (250PS), the 4.0-liter, DOHC V6 24-valve flagship DF300AP/250AP delivers plenty of power and torque.
- New lower unit features the Suzuki Selective Rotation system—the world's first selective rotation outboard—and a new two-way water inlet.
- Suzuki's Precision Control (Electronic Throttle and Shift System) offers smooth and positive gear operation.
- Suzuki's Lean Burn Control system combined with Suzuki Precision Control delivers remarkable fuel economy over a wide operating range and smooth power transitions when power is required.
- Suzuki's O₂ Sensor Feedback Control system delivers low exhaust emissions.

Suzuki Receives Seventh NMMA Innovation Award

When it comes to leading edge technology, Suzuki has time and again, delivered technological advancements that put Suzuki outboards at the forefront of advanced outboard motor design. Recognizing the DF300AP as the most innovative outboard introduced over the past year, the National Marine Manufacturers Association (NMMA) awarded the DF300AP with its prestigious NMMA Innovation Award for 2012 marking an unprecedented seventh win for Suzuki and following last year's award with the new DF50A/40A, a second, unprecedented back-to-back win for Suzuki. The number of awards that Suzuki has garnered over the years reflects the company's strong desire to provide its customers with the very best, most innovative and most reliable products possible and acknowledges the outstanding work of the company's engineering staff.



New Lower Unit

Compared to the original DF300, the biggest changes you'll find on these outboards are in the lower unit, which was redesigned for the Suzuki Selective Rotation system—the world's first integration of regular and counter-rotation models into a single unit. The system consists of a new drive gear layout in the lower unit that allows the outboard to operate in either regular or counter-rotation mode, and a switch that connects to a circuit in the engine compartment that engages the counter-rotation mode. Like the DF300, the new DF300AP/250AP utilizes an aggressive final drive ratio of 2.08:1 allowing it to turn a 406mm (16-inch) diameter propeller available in various pitch size for optimum performance on a wide variety of boats. Changes to gear designs provide greater durability, and adding a two-way water inlet changes water flow into the cooling system for increased cooling efficiency.

Suzuki Selective Rotation

In multi-outboard installations on large boats, a counter-rotation outboard is usually paired with a regular rotation model to help keep the boat traveling on an even keel and in a straight line. The DF300AP/250AP is built with special counter rotating gearing in the lower unit, which causes the prop to rotate in the opposite direction. Suzuki Selective Rotation eliminates the need to purchase a dedicated counter-rotation outboard by using a special switch that when connected to a circuit inside of the engine compartment, turns a regular rotation outboard into a counter-rotation model with a counter rotational propeller.* This industry first is made possible through a special, unified design of gears, shaft, and bearings in the lower unit that are designed to operate reliably and efficiently in either regular or counter-rotation directions.

* Make sure you consult with your dealer before changing Regular Rotation to Counter Rotation (or vice versa).
 ** The special switch & propeller need to be purchased separately to change the rotation.

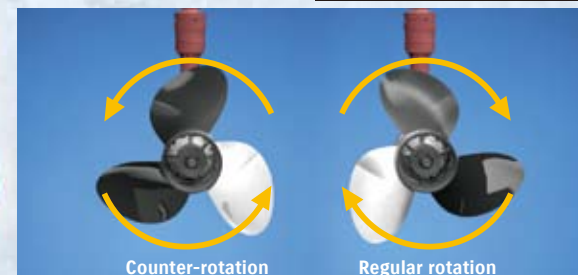

Superior Durability

With the addition of Suzuki Selective Rotation, gears in the lower unit were redesigned using a different alloy and slightly larger diameters delivering greater rigidity. The gears are specially heat treated creating gears that are highly durable.



Two-way Water Inlet

The engine's cooling system relies on water supplied through low water intakes located on the lower unit. Utilizing this dual low water inlet configuration increases water flow into the lower unit, which delivers greater cooling efficiency. Positioning the forward inlet at the gear case nose delivers a greater water supply especially at high speeds. The second inlet is also positioned lower allowing the DF300AP/250AP to operate in shallow water conditions.

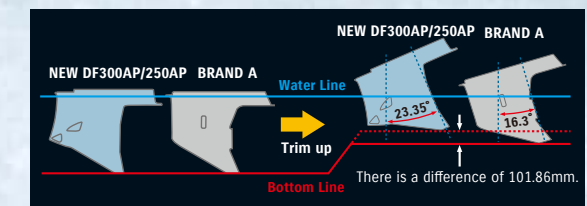
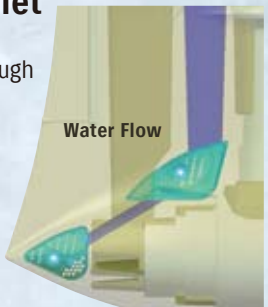

Newly Designed Low Drag Gear Case

The new DF300AP/250AP features a redesigned low drag gear case developed to accommodate the new gears utilized in the Suzuki Selective Rotation system. The case itself is actually larger than the previous model to provide increased gear durability, however it is designed with a smoother, more hydrodynamic shape that allows it to move through the water with less drag and greater efficiency. Areas with the highest drag are indicated in red in the illustrations below. The comparison shows that the new design allows the lower unit to slice through the water with less drag.

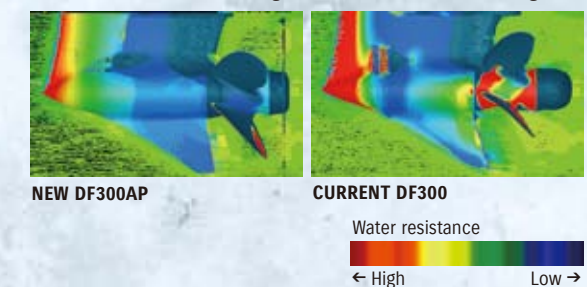

Suzuki's Lean Burn Control System

Suzuki's innovative Lean Burn Control System was first introduced on the DF90A/80A/70A to great acclaim from boaters and the media alike. It predicts fuel needs according to operating conditions allowing the engine to run on a more efficient fuel mixture through the use of a lean air-fuel ratio. It delivers its benefits over a wide operating range, providing significant improvements in fuel economy from low-speed operation into the cruising range. Combining this system with the Suzuki Precision Control, electronic throttle and shift system, allows the operator precisely control to increase or decrease the engine RPM for improved fuel economy over a wider operation range. This combination also delivers smooth power transitions throughout the entire RPM range. In-house testing shows that while cruising, the DF300AP is 14% more economical than the original non-Lean Burn DF300 without sacrificing any power of the original DF300.



Comparison of Fuel Consumption per 1 Liter of Fuel (New DF300AP vs. Original DF300)

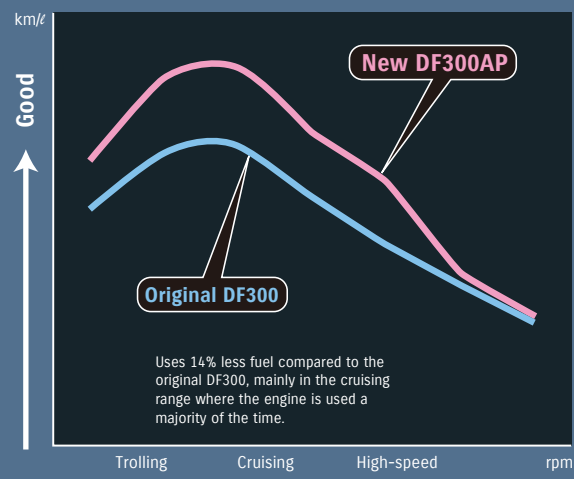

Data used in the graphs were obtained through in-house testing under uniformed conditions. Results will vary depending upon operating conditions (boat design, size, weight, weather, etc.)

O₂ Sensor Feedback Control System

Both the DF300AP and DF250AP are equipped with an O₂ Sensor Feedback Control system that enables emissions to be cleaner and more stable. The system controls the air to fuel ratio across each of the engine's operating ranges providing an optimum amount of fuel to the engine regardless of rpm.

Cleaner, More Efficient Operation

Suzuki's advanced four-stroke technology delivers cleaner and more efficient operation that conforms to the Recreational Craft Directive (RCD) - Directive 2003/44EC of the European Parliament and of the Council, and has received three-star ratings from the California Air Resources Board (CARB).



EURO 1 Emissions Standards (EU Directive 2003/44/EC) Label



CARB Three-Star Label

Suzuki's Advanced Technology Delivers the Utmost in Performance VVT (Variable Valve Timing)

Suzuki's engineers designed the 4.0-liter V6 engine with an aggressive cam profile that delivers maximum output and performance at high rpm. In coupling this cam profile with Suzuki's advanced Variable Valve Timing (VVT), the DF300AP/250AP delivers the additional torque that outboards need for accelerating in the low to mid-range. VVT achieves this by adjusting the timing of the intake valves, allowing them to open before the exhaust valves are fully closed, creating a momentary overlap in the timing where both sets of valves are open. Using VVT, this overlap can be increased or decreased by altering intake timing with the camshaft resulting in optimum timing for low and mid-range operation.

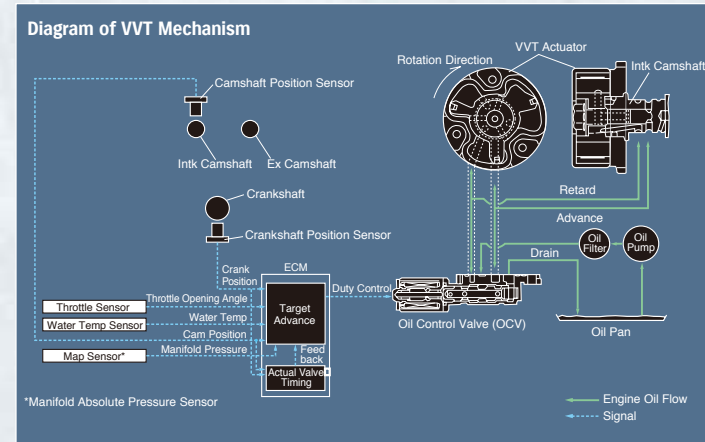

32-Bit ECM and Suzuki's Multi Point Sequential Electronic Fuel Injection

Suzuki pioneered the use of multi-point sequential electronic fuel injection in four-stroke outboards with the introduction of the original DF60 and DF70. At the heart of the DF300AP/250AP's multi point sequential fuel injection system is the ECM (Engine Control Module), which constantly monitors a large amount of data, in real time, from a series of sensors placed in critical areas on the engine. This comprehensive network of sensors includes the Manifold Absolute Pressure Sensor, Crankshaft Position Sensor, Intake Air Temperature Sensor, Cylinder Wall Temperature Sensor, Camshaft Position Sensor, and Exhaust Jacket Temperature Sensor. Using a very powerful 32-bit computer, the ECM processes data from all of these sensors and instantly calculates the optimum amount of fuel to be injected at high pressure into each of the V6's cylinders by the multi point sequential fuel injection system. Benefits of this system include reduced exhaust emissions, which allow the DF300AP/250AP to comply with the California Air Resource Board (CARB) 3-Star emission requirements, lower fuel consumption, smoother starts, crisper acceleration, smoother performance, and maximum efficiency.

Suzuki Precision Control (Electronic Throttle and Shift Systems)

Suzuki Precision Control is a technologically advanced computer-based control system that replaces the mechanical control cables found in conventional control systems with electronic wiring that eliminates the source of friction and resistance. While you enjoy smooth, little friction throttle and shift operation, the system's computer is processing and transmitting commands in real-time to actuators at the engine that deliver precise throttle controls with smoother, decisive shifting. This is most evident in the low rpm range where operation is noticeably smooth and accurate. When combined with Suzuki's Lean Burn Control System it allows control of fuel and air flow to boost the limit of the controllable revolution range improving fuel economy over a wide operating range. Suzuki Precision Control also features built-in systems that help guard the engine and drive against damage due to mishandling, and its design and simple wiring make installation easy, reducing the time required for rigging and adjustment. The system offers precision control for single, twin or triple installation as well as dual station operation.

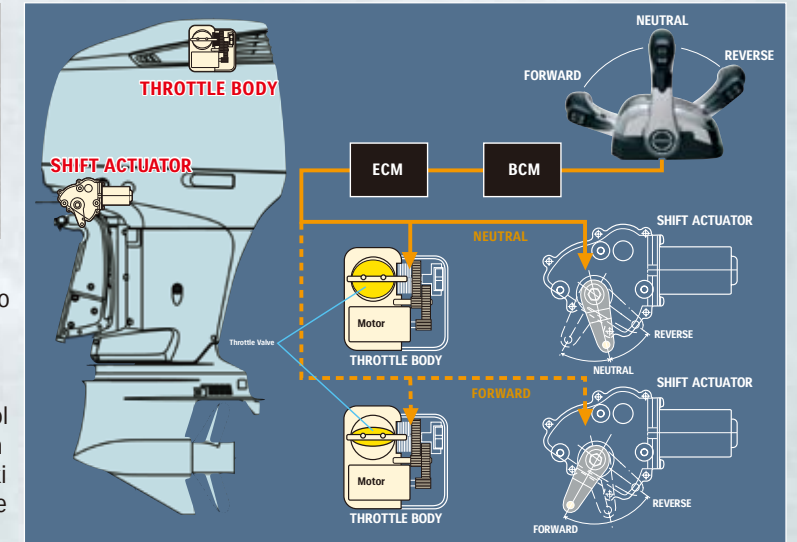

Control Panel Suzuki's Remote Control System puts precision operation right at your fingertips.

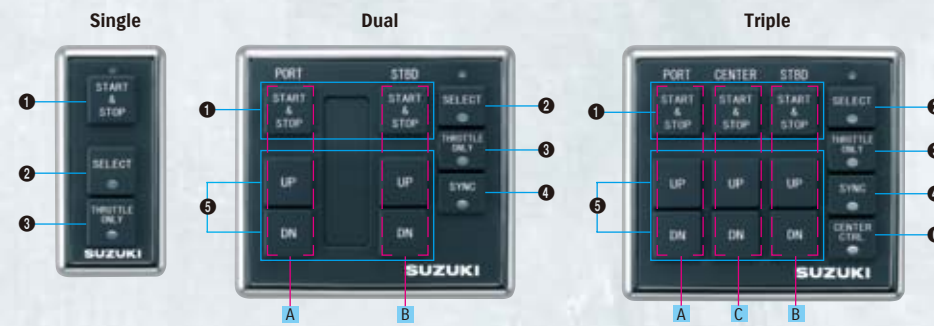

- 1 **Start Stop Switch**
Switches the engine ON/OFF
 - 2 **Station Select Switch**
Selects throttle/shift control from one driving station to the second driving station
 - 3 **Throttle Only Switch**
Keeps the drive in neutral for throttle only operation.
 - 4 **Engine Synchronize Switch**
Synchronizes engine RPM on boats with two or more outboards.
 - 5 **Tilt Up & Down Switch**
Tilt control for each engine.
 - 6 **Center Engine Control Switch**
The center engine is controlled with the port-side remote controller (auto on). With the control in the neutral position, this switch locks the center engine in neutral letting you operate with the remaining two outboards.
- A Port-Side Engine Controls
B Starboard-Side Engine Controls
C Center Engine Controls

Suzuki Modular Instrument System (SMIS)

SUZUKI MODULAR INSTRUMENT SYSTEM (SMIS) uses an easy to connect and expandable cable system to transmit graphic and numerical data to Multi-Function gauges. This easy to install and set up system can be used with nearly any boat and the DF300AP/250AP SUZUKI outboard. When connected to an *NMEA2000® compatible system, the gauges can display real-time readings from compatible electronic probes and the exclusive SMIS engine interface to monitor engine functions. (Engine Monitor with 4" gauge only)

* registered trademark of National Marine Electronics Association

SMIS MULTI-FUNCTION GAUGE

The 4" multi-function gauge uses a state-of-the-art high-contrast, dot matrix display to monitor real-time graphic and numerical digital data. When connected into the SMIS system, it can monitor engine functions, operate as a speedometer, tachometer, GPS*, and many others. (*GPS requires additional hardware.) The 2" multi-function gauge is capable of all functions of the 4" gauge except engine monitoring functions.

<p>4" SMIS Multi-Function Gauge</p> <p>Quad analog page as a tachometer, a volt meter, a water-pressure gauge and a speedometer for single engine</p>	<p>Examples of display**</p> <p>Engine trim page as a trim gauge for single engine</p> <p>Single analog page as a tachometer for single engine</p> <p>Single analog page as a speedometer</p> <p>Diagnostics page</p>	<p>2" SMIS Multi-Function Gauge</p> <p>Fuel manager page</p>	<p>Examples of display**</p> <p>as a volt meter for single engine</p> <p>Fuel manager page</p> <p>Engine trim page as a trim gauge for single engine</p>
--	--	---	---

** The detail instructions of display-operation are explained in the Operation & Installation Manual.

Long Track Intake Manifold

Another performance enhancing feature on the DF300AP/250AP is a tuned long track intake manifold. Using long intake pipes tuned to provide smooth airflow into the engine the system provides the DF300AP/250AP with enhanced low-end power.

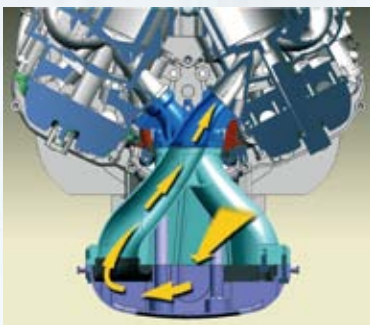

Large Air Intake with Water Separator

The DF300AP/250AP is designed with a large air induction port to maximize airflow into the engine in order to obtain maximum power output. The increased airflow produces more low- to mid-range torque and provides a wide power band that is necessary in an outboard engine. Suzuki also designed the system with a water separator, which aids in keeping water out of the electronic throttle body and a heat shield to keep intake air from being heated by the engine.

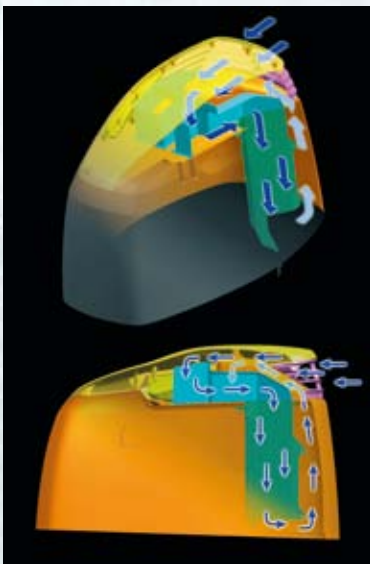

Spherical Bore Throttle Body

An 81mm spherical bore throttle body smoothes the turbulent airflow into the engine that occurs as the throttle begins to open. Providing a smoother airflow during acceleration results in increased throttle control and stable engine operation at low rpm.

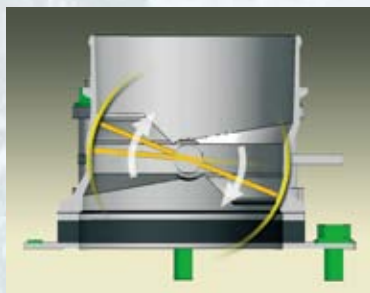

Fuel Cooler

The cooler the fuel the denser it is, and the denser it is the better performance it delivers. Incorporating a fuel cooler in the DF300AP/250AP's fuel delivery system cools the fuel before it enters the engine. Providing the engine with an optimum fuel supply results in better combustion and more performance.

Strengthened Forged Pistons

The upper portion of pistons used in the big V6 engine is treated with an alumite coating that increases heat resistance. A resin coating applied to the piston skirt increases resistance to wear and reduces friction.



Offset Driveshaft

Suzuki outboards are among the compact outboards in their respective classes. That's due in part to the utilization of Suzuki's proven offset driveshaft system. This design places the crankshaft in front of the driveshaft through the use of intermediate gear reduction. In addition to providing an increase in power performance and adding to the compactness of the outboard, this system moves the outboard's center of gravity forward, resulting in contribution to weight distribution, balance, directional stability, and less vibration.

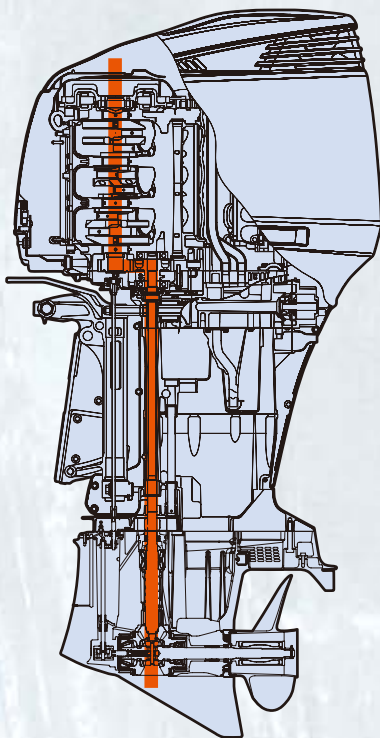

Two-Stage Cam Drive System

The DF300AP/250AP utilizes a two-stage cam drive system that incorporates both gears and a chain. First stage gears transfer power between the crankshaft and the drive shaft from which a second stage utilizes a chain to deliver power from the driveshaft to the camshaft. This system allows for the use of smaller cam sprockets, which in turn allow for a reduction in valve angles also reducing the size of the cylinder head. An automatic hydraulic tensioner incorporated into the timing chain system keeps the chain properly tensioned and provides years of maintenance-free operation.



Suzuki Water Detecting System

Water in the fuel can be the source of poor combustion, lower power output, and corrosion. To help protect the engine from moisture in the fuel, the DF300AP/250AP is the first Suzuki outboard to utilize a water detecting fuel filter that alerts the operator with both visual and audio warnings when water is present in the fuel.



Water-Cooled Voltage Regulator

The outboard's electric system includes a water-cooled voltage regulator that dissipates heat in the regulator to enhance engine durability.

Fuse Box

Fuses protecting the DF300AP/250AP's electric system are assembled into a single fuse box located under the cowling on the side front-port of the outboard motor, which provides convenient access while offering a clean exterior.

Highly Reliable Direct Ignition System

Supplying spark to the big V6 engine is an advanced ignition system that utilizes integral type spark plug caps with built-in ignition coils. The system is controlled by the outboard's powerful 32-bit computer and provides each cylinder with optimum spark timing. In addition to reducing the number of parts and simplifying the wiring system, this arrangement greatly reduces electronic engine "noise" that can interfere with VHF radios, fish finders, and other marine electronics.



Easier Maintenance Dual Engine Flush Ports

The buildup of sand and salt in the engine's cooling system can lead to engine damage. To aid in reducing such buildup, the DF300AP/250AP is designed with two freshwater flush ports that make flushing of the cooling system as convenient and easy as possible. With one port located on the rear panel and the second on the front panel, access is easy and flushing out the system is possible whether the boat is in or out of the water.



Convenient Dual Circuit Charging System

The DF300AP/250AP incorporates a dual circuit charging system that can be adapted* to accommodate the dual-battery configurations often used on large boats. When used in this configuration the system is designed to charge both the main and auxiliary batteries simultaneously but on independent circuits. With this you can drain down the accessory battery powering your electronics and still have a fully charged main battery for starting the motor.

* Utilization of this system requires the purchase of an optional wiring harness.

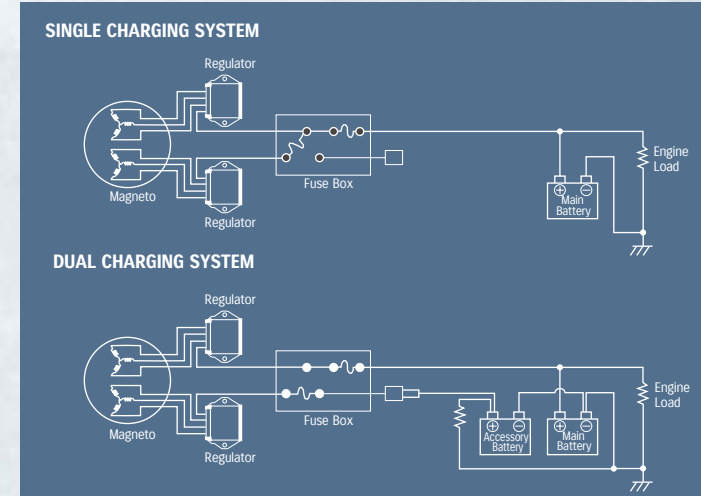

Suzuki Troll Mode System (Optional Equipment)

Suzuki's Troll Mode system provides finer control over engine speed at low rpms to keep your boat moving at a constant speed while trolling. When the system is engaged, revs are controlled with an independent control switch that adjusts engine revs in 50rpm increments over a range spanning from idle to 1,200rpm. The system includes a control switch, which can be mounted nearly anywhere on the console, and a tachometer, and is compatible with Suzuki's SMIS digital gauges or the dual scale analog gauges.



Suzuki's Anti Corrosion Finish

The outside of the DF300AP/250AP is covered with Suzuki's anticorrosion finish that is specially formulated to increase the durability of the engine and help protect parts of the aluminum exterior that are constantly exposed to saltwater. This advanced finish offers maximum bonding to the outboard's aluminum surface, creating an effective treatment against corrosion.

